

X-TIGUA

by Palazzoli

Lighting to save



excellence
FROM ITALY

Palazzoli

Multiplying the power of light

X-TIGUA is a new range of high luminous flux luminaires, offering floodlights, suspension luminaires and road tunnel light fixtures. The modular design of X-TIGUA means it can be adapted for a wide range of installation requirements.



High performance

A system of high-quality internal components (LEDs and power supply systems) is built into the body, made in a low-copper aluminium alloy (aeronautical grade), guaranteeing:

- High performance
- Energy saving
- Resistance in extreme environments

X-TIGUA fulfilling all illumination requirements

Floodlight

Page 4



The floodlights are available in 3 sizes, ranging from 27000 lm to 65000 lm.

Perfect for **illuminating sports facilities**, large open spaces, slip roads, junctions and roundabouts.

Suspension

Page 14



The suspension light fixtures are in 2 sizes, ranging from 21000 lm to 49000 lm.

Perfect for **illuminating great heights**.

A range designed for **high temperature environments** up to +70°C.

Tunnel

Page 22



The tunnel range consists of:

X-TIGUA floodlights, from 19000 lm to 63000 lm, ideal for **reinforcement lighting**.

TIGUA floodlights, from 4000 lm to 16000 lm, ideal for **permanent lighting**.

Floodlight

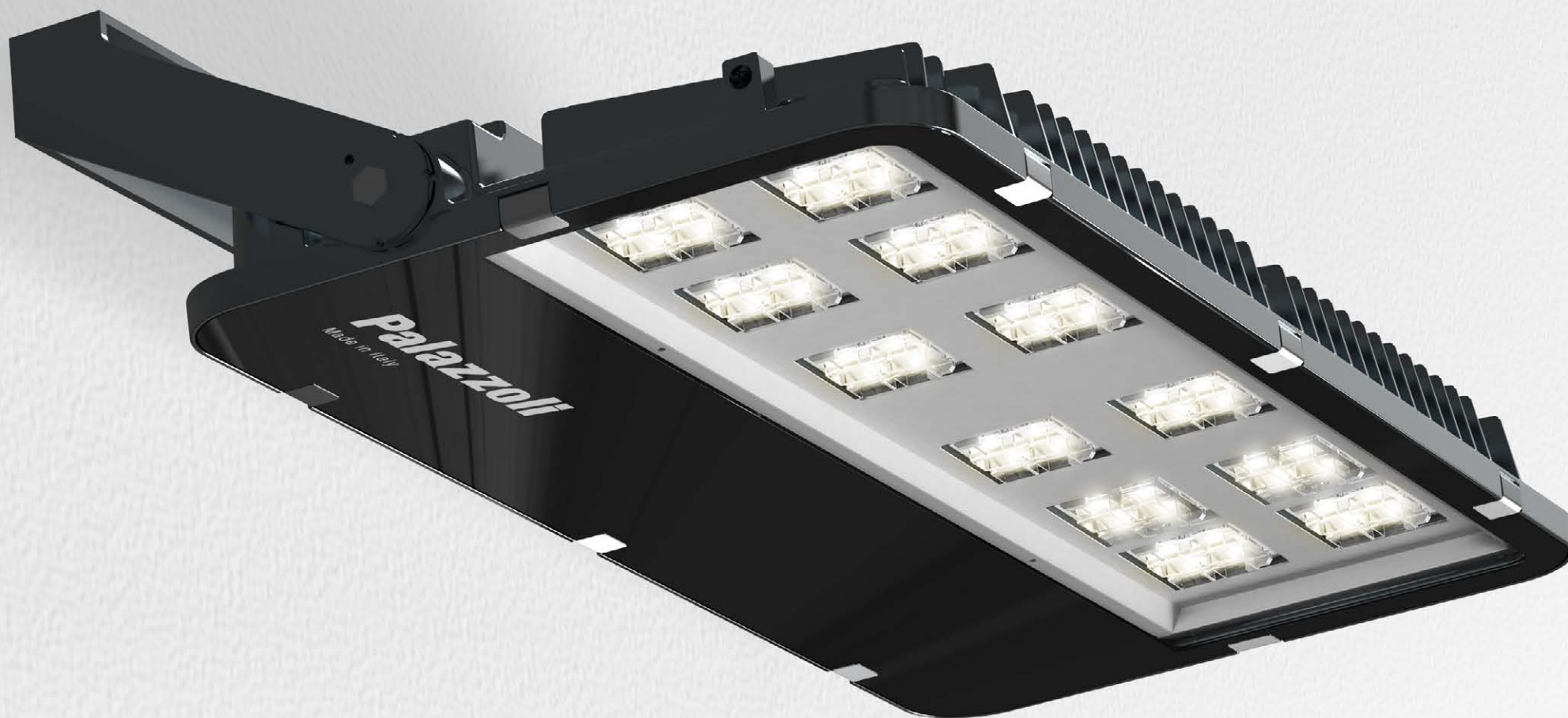

Sports facilities

X-TIGUA is the ideal lighting solution for outdoor sports facilities, from tennis courts and five-a-side football pitches to outdoor pools and small 11-a-side football stadiums.

The wide range of optics can meet any facility's needs and guarantees superbly uniform illuminance and optimal visual comfort for players and spectators alike. The body of each floodlight has a built-in bracket for tilting it into the optimal position. X-TIGUA can be mounted onto poles or on fixed platforms on light towers.



Open spaces

X-TIGUA is perfect for illuminating ports, airports, car parks, depots and more.

This floodlight guarantees an energy efficient light fitting and can ensure a sizeable saving even over a short period of time, as there is no maintenance required and it brings a fast return on investment.

A system of high-quality internal components guarantees increased reliability, safety and durability.



Slip roads, junctions and roundabouts

X-TIGUA is a new lighting system, ideal for illuminating slip roads, junctions, roundabouts, car parks, roads within industrial areas and more.

This floodlight can be installed onto light towers, while the technical design of the lighting system ensures the roadway below is correctly lit, offering excellent visibility and highlighting any potentially dangerous areas.





Corrosion resistant

A body made in aluminium alloy with low-copper content and passivation treatment and coating makes this an ideal choice for installation where chemicals are present.



Visual comfort

This range of optics consists of 3 symmetrical beams, 3 asymmetrical beams and 1 suited to roadway; this makes it suitable for all kinds of installations, while guaranteeing optimum visual comfort.



Easy to be installed

The bracket is equipped with a goniometer and in-built grub screw, allowing the floodlight to be adjusted around -110° to $+110^\circ$. The driver, built into the luminaire, allows for fast and secure cabling.

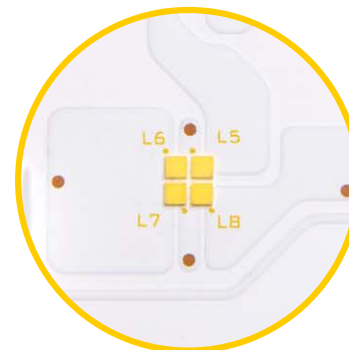

Reliable

In latest-generation LEDs, the luminous flux remains unaltered over time. X-TIGUA lasts for over 100,000 hours in ambient temperatures of $+55^\circ\text{C}$.

Size M

497x475x78

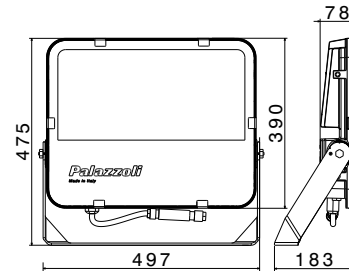

Flux ranges from 27000 to 33000 lm, comparable to a 400W JM (metal-halide) lamp.
Installation height: 9 - 20 m.

Ideal for:
amateur sports facilities and perimeter lighting for large open spaces.

Size L

814x452x78

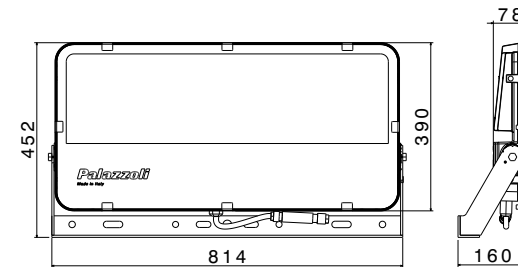
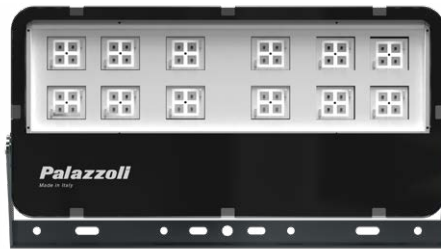

Flux ranges from 38000 to 49000 lm, comparable to a 600W SAP (sodium high pressure) lamp.
Installation height: 15 - 25 m.

Ideal for:
large areas such as ports, airports and large car parks.

Size XL

550x875x78

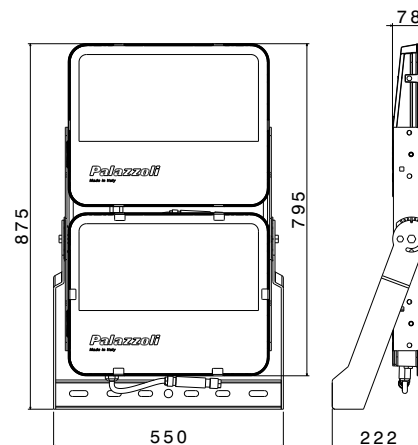

Flux ranges from 53000 to 65000 lm, comparable to a 1000W JM (metal-halide) lamp.
Installation height: 20 - 35 m.

Ideal for:
light towers on roads or small football stadiums.



Wall-mounted

The robust supplied bracket gives wall-mounted floodlights a rotation range between -110° and $+110^{\circ}$. A goniometer is built into the luminaire body to facilitate its positioning.



Pole-mounted

With accessories (floodlight-bearing cross beams, codes 818990 and 818991), the luminaires can be quickly installed on poles (60 - 76mm in diameter). There are various fixing points for installing a single luminaire or multiple luminaires.



Light tower

The supplied bracket allows the floodlights to be installed quickly and securely onto rings and onto the floodlight-bearing supports on various fixed and mobile light towers. The power supply components inside the luminaire simplify the mounting process.

Precision optics

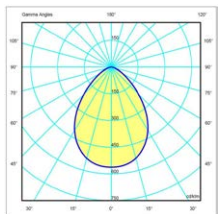

Symmetrical 81°
extra wide beam

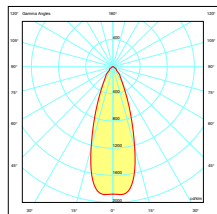

Symmetrical 36°
narrow beam

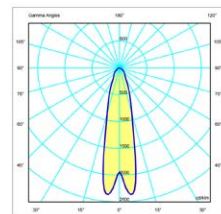

Symmetrical 18°
narrow beam

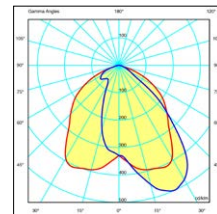

Asymmetrical 23°
extra wide beam

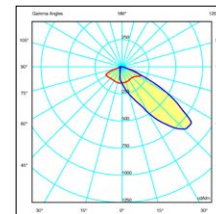

Asymmetrical 43°
narrow beam

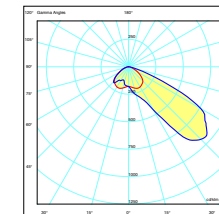

Asymmetrical 55°
narrow beam

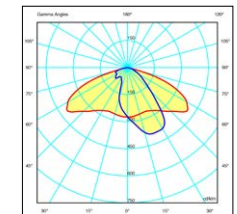

Roadway 65°
wide beam



X-TIGUA, the new Palazzoli floodlight, is the best way to illuminate sports facilities, large open spaces, slip roads, junctions and roundabouts. A die-cast aluminium body with very low copper content, anti-corrosion treatment, and a 4mm thick diffuser in extra-clear tempered glass guarantees the durability of this floodlight. It is available in 3 floodlight sizes (M, L and XL), providing actual output up to 65000 lm. The rear heat sink allows for excellent heat management and increases the longevity of the luminous flux. The power supply unit guarantees excellent light quality with <1% flicker, allowing for exceptional video surveillance.

The input surge protection secures the device against surges up to 8kV, extending product lifetime, even when used in outdoor installations. Latest-generation CSP (Chip Scale Package) LEDs can maintain luminous flux over a period of more than 100,000 hours, even in ambient temperatures up to 55°C. The 4000K colour temperature and CRI≥80 guarantee ideal lighting quality wherever the product is installed. The optics are made using non-ageing, UV-resistant PMMA lenses with >90% efficiency and >95% transparency. The range consists of 3 symmetrical beams, 3 asymmetrical beams and 1 suited to roadway, which combine to make the perfect solution for various technical lighting design projects. The connector supplied with the luminaire allows for fast and secure cabling. X-TIGUA offers a wide range of accessories for mounting luminaires on walls or poles, or installing them on light towers. As such, it is easily adapted for varied lighting requirements.

A front grid is also available to protect the unit.

The photometric curves (LDT files) are available on www.palazzoli.com

Body material	Low-copper aluminium alloy (EN 44300)
Surface treatment	Passivation with fluoro-zirconium treatment
Surface coating/colour	Non-toxic polyester, anti UV, kiln-polymerised coating, colour: RAL 7011
Diffuser material	Extra clear tempered glass, thickness: 4mm
Net weight	9.5 kg - 13.5 kg - 23.2 kg
Protection rating	IP66 as per IEC/EN 60598-1
Impact resistance	IK08 as per IEC/EN 62262 + IEC/TR 62696
Mounting system	U bracket with adjustment range of -110° to 110°
Optics features	Non-ageing, UV-resistant PMMA lenses with >90% efficiency and >95% transparency
Actual luminaire efficiency	Up to 130 lm/W
Colour temperature	4,000K (other temperatures on request)
Colour rendering index values	CRI ≥ 80 (good - according to EN 62717 criteria)
Colour consistency	MacAdam 4-step
Photobiological risk	RG0 - Exempt Group (EN 62471)
Residual flicker	< 1%
Lifetime	L80 B20 @100,000H Tq=40°C; Tq= 55°C (HT version)
Insulation class	II
Supply voltage	220-240V 50/60Hz
Surge protection	8 kV common mode, 6kV differential mode (EN 61000-4-5)
Power factor	≥ 0.95
Ambient functioning temp.	Min -30°C to Max +45°C; Max +55°C (HT version)
Power supply	Quick connector
Max. conductor cross-section	1.5 mm²
Entry cable diameter	Min 7 mm; Max 13 mm
Wind load surface	Side M 0.04 m² - Front M 0.18 m²; Side L 0.04 m²; Front L 0.30 m²; Side XL 0.15 m² - Front XL 0.4 m²
Warranty	2 years with optional extension to 5
Ambient storage temp.	Min -40°C; Max +70°C
Certification and approval marks	CE, ENEC, DIN 18032-3/EN 13964
Directives	2014/30/EU (EMC), 2014/35/EU (LVD), 2011/65/EU (RoHS)
Product standards	EN 60598-1, EN 60598-2-1, EN 60598-2-5, EN 62471, EN 62493, IEC/TR 62778, EN55015, EN 61547, EN 61000-3-2, EN 61000-3-3, EN 50581, EN 13964 Annex D, EN 60598-2-24

Floodlight

100,000h

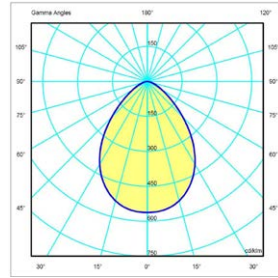

Professional LED floodlights
with **81° symmetrical extra wide beam optics**
IP66

No. of LEDs	Light fixture size	Device power (W)	Nominal flux (lm) Tj= 25 °C	Output flux (lm) Tq= 25 °C	Version	Palazzoli code	Pack Qty
28	M	235	33250	28788	standard on-off	818028	1
32	497x475	270	38000	32940		818032	1
40	L	336	47500	41160		818040	1
48	814x452	400	57000	48800		818048	1
56	XL	470	66500	57575		818056	1
64	550x875	535	76000	65270		818064	1

Equipment included: wall-mounting bracket.
Power supply: 2Px1.5 mm² quick connector and 1.5 mm² H07RN-F cable, 0.2m in length.
Notes: the stated values may be subject to a +/- 7% tolerance.

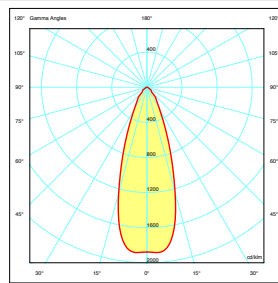

Professional LED floodlights
with **36° symmetrical narrow beam optics**
IP66

No. of LEDs	Light fixture size	Device power (W)	Nominal flux (lm) Tj= 25 °C	Output flux (lm) Tq= 25 °C	Version	Palazzoli code	Pack Qty
28	M	235	33250	28670	standard on-off	818128	1
32	497x475	270	38000	32805		818132	1
40	L	336	47500	40992		818140	1
48	814x452	400	57000	48600		818148	1
56	XL	470	66500	57340		818156	1
64	550x875	535	76000	65003		818164	1

Equipment included: wall-mounting bracket.
Power supply: 2Px1.5 mm² quick connector and 1.5 mm² H07RN-F cable, 0.2m in length.
Notes: the stated values may be subject to a +/- 7% tolerance.

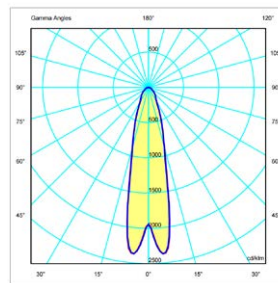

Professional LED floodlights
with **18° symmetrical narrow beam optics**
IP66

No. of LEDs	Light fixture size	Device power (W)	Nominal flux (lm) Tj= 25 °C	Output flux (lm) Tq= 25 °C	Version	Palazzoli code	Pack Qty
28	M	235	33250	26555	standard on-off	818628	1
32	497x475	270	38000	30510		818632	1
40	L	336	47500	37968		818640	1
48	814x452	400	57000	45200		818648	1
56	XL	470	66500	53110		818656	1
64	550x875	535	76000	60455		818664	1

Equipment included: wall-mounting bracket.
Power supply: 2Px1.5 mm² quick connector and 1.5 mm² H07RN-F cable, 0.2m in length.
Notes: the stated values may be subject to a +/- 7% tolerance.

Floodlight

100,000h

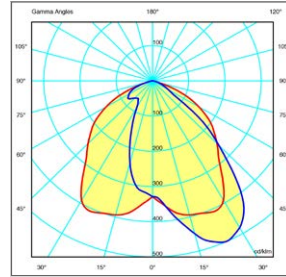

No. of LEDs	Light fixture size	Device power (W)	Nominal flux (lm) Tj= 25 °C	Output flux (lm) Tq= 25 °C	Version	Palazzoli code	Pack Qty
28	M	235	33250	28788	standard on-off	818228	1
32	497x475	270	38000	32940		818232	1
40	L	336	47500	41160		818240	1
48	814x452	400	57000	48800		818248	1
56	XL	470	66500	57575		818256	1
64	550x875	535	76000	65270		818264	1

Professional LED floodlights with **23° asymmetrical extra wide beam optics** IP66

Equipment included: wall-mounting bracket.
Power supply: 2Px1.5 mm² quick connector and 1.5 mm² H07RN-F cable, 0.2m in length.
Notes: the stated values may be subject to a +/- 7% tolerance.

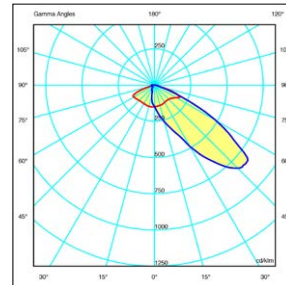

No. of LEDs	Light fixture size	Device power (W)	Nominal flux (lm) Tj= 25 °C	Output flux (lm) Tq= 25 °C	Version	Palazzoli code	Pack Qty
28	M	235	33250	28788	standard on-off	818328	1
32	497x475	270	38000	32940		818332	1
40	L	336	47500	41160		818340	1
48	814x452	400	57000	48800		818348	1
56	XL	470	66500	57575		818356	1
64	550x875	535	76000	65270		818364	1

Professional LED floodlights with **43° asymmetrical narrow beam optics** IP66

Equipment included: wall-mounting bracket.
Power supply: 2Px1.5 mm² quick connector and 1.5 mm² H07RN-F cable, 0.2m in length.
Notes: the stated values may be subject to a +/- 7% tolerance.

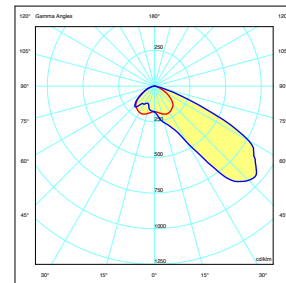

No. of LEDs	Light fixture size	Device power (W)	Nominal flux (lm) Tj= 25 °C	Output flux (lm) Tq= 25 °C	Version	Palazzoli code	Pack Qty
28	M	235	33250	28905	standard on-off	818528	1
32	497x475	270	38000	32670		818532	1
40	L	336	47500	40656		818540	1
48	814x452	400	57000	49720		818548	1
56	XL	470	66500	56870		818556	1
64	550x875	535	76000	64735		818564	1

Professional LED floodlights with **55° asymmetrical narrow beam optics** IP66

Equipment included: wall-mounting bracket.
Power supply: 2Px1.5 mm² quick connector and 1.5 mm² H07RN-F cable, 0.2m in length.
Notes: the stated values may be subject to a +/- 7% tolerance.

Floodlight

100,000h

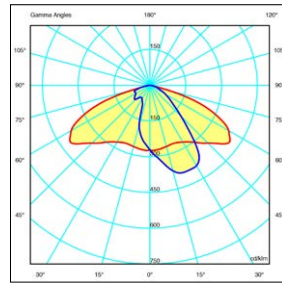

No. of LEDs	Light fixture size	Device power (W)	Nominal flux (lm) Tj= 25 °C	Output flux (lm) Tq= 25 °C	Version	Palazzoli code	Pack Qty
28	M	235	33250	28670	standard on-off	818428	1
32	497x475	270	38000	32805		818432	1
40	L	336	47500	40992		818440	1
48	814x452	400	57000	48600		818448	1
56	XL	470	66500	57340		818456	1
64	550x875	535	76000	65003		818464	1

Professional LED floodlights
with **65° roadway wide beam optics**
IP66

Equipment included: wall-mounting bracket.
Power supply: 2Px1.5 mm² quick connector and 1.5 mm² H07RN-F cable, 0.2m in length.
Notes: the stated values may be subject to a +/- 7% tolerance.

Floodlight accessories



Cross beam for
pole-top mounting
1 or 2 X-TIGUA floodlights



Cross beam for
pole-top mounting
2 or 4 X-TIGUA floodlights

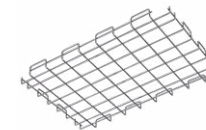

Protection grid
for X-TIGUA floodlights

Manufacturing material	Light fixture size	Palazzoli code	Pack Qty
galvanised steel	M,L,XL	818990	1

Manufacturing material	Light fixture size	Palazzoli code	Pack Qty
galvanised steel	M,L,XL	818991	1

Manufacturing material	Floodlight size	Palazzoli code	Pack Qty
galvanised steel	M, XL*	818992	1
	L	818993	1

Notes: cross beam suitable for mounting up to 2x floodlights size M, L or XL.
The cross beam can be installed \varnothing 60 - \varnothing 76 mm poles.

Notes: cross beam suitable for mounting 2x floodlights size L or 4x floodlights size M or XL.
The cross beam can be installed on \varnothing 60 to \varnothing 76 mm poles.

Notes: *for size XL, use 2x grids size M.

Floodlight

100,000h

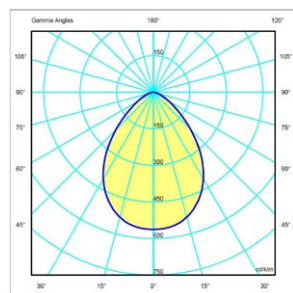

Professional LED floodlights **HT +55°**
with **81° symmetrical extra wide beam optics**
IP66

No. of LEDs	Light fixture size	Device power (W)	Nominal flux (lm) Tj= 25 °C	Output flux (lm) Tq= 25 °C	Version	Palazzoli code	Pack Qty
28	M	166	27009	21613	standard on-off	818028HT	1
32	497x475	189	30867	24570		818032HT	1
40	L	237	38584	30857		818040HT	1
48	814x452	284	46301	36920		818048HT	1
56	XL	332	54018	43226		818056HT	1
64	550x875	378	61734	49140		818064HT	1

Equipment included: wall-mounting bracket.
Power supply: 2Px1.5 mm² quick connector and 1.5 mm² H07RN-F cable, 0.2m in length.
Notes: the stated values may be subject to a +/- 7% tolerance.

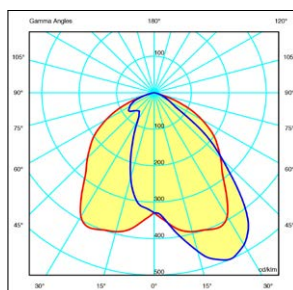

Professional LED floodlights **HT +55°**
with **23° symmetrical extra wide beam optics**
IP66

No. of LEDs	Light fixture size	Device power (W)	Nominal flux (lm) Tj= 25 °C	Output flux (lm) Tq= 25 °C	Version	Palazzoli code	Pack Qty
28	M	166	27009	21613	standard on-off	818228HT	1
32	497x475	189	30867	24570		818232HT	1
40	L	237	38584	30857		818240HT	1
48	814x452	284	46301	36920		818248HT	1
56	XL	332	54018	43226		818256HT	1
64	550x875	378	61734	49140		818264HT	1

Equipment included: wall-mounting bracket.
Power supply: 2Px1.5 mm² quick connector and 1.5 mm² H07RN-F cable, 0.2m in length.
Notes: the stated values may be subject to a +/- 7% tolerance.

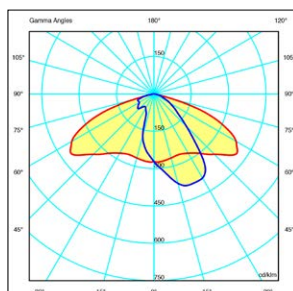

Professional LED floodlights **HT +55°**
with **65° roadway wide beam optics**
IP66

No. of LEDs	Light fixture size	Device power (W)	Nominal flux (lm) Tj= 25 °C	Output flux (lm) Tq= 25 °C	Version	Palazzoli code	Pack Qty
28	M	166	27009	19920	standard on-off	818428HT	1
32	497x475	189	30867	22680		818432HT	1
40	L	237	38584	28440		818440HT	1
48	814x452	284	46301	34080		818448HT	1
56	XL	332	54018	39840		818456HT	1
64	550x875	378	61734	45360		818464HT	1

Equipment included: wall-mounting bracket.
Power supply: 2Px1.5 mm² quick connector and 1.5 mm² H07RN-F cable, 0.2m in length.
Notes: the stated values may be subject to a +/- 7% tolerance.

Suspension



Shipyards

The high luminous flux of X-TIGUA makes it ideal for lighting the great heights found in shipyards. The low-copper aluminium alloy body receives a double passivation treatment and coating to maximise its resistance in corrosive environments. The IP66 protection rating guarantees total protection against the infiltration of dust and water from powerful jets.



Steel plants

X-TIGUA is ideal for extreme environments such as steelworks and metallurgical plants. Products in the VHT range can be installed in any environment where temperatures reach +70°C. The components specially selected for this product guarantee a 130 lm/W efficiency.



Hangars

X-TIGUA produces lighting design solutions for installation at heights of over 15 metres. Inside a hangar, Palazzoli suspension luminaires can provide uniform lighting for the area below, guaranteeing over 120,000 hours of performance and so significantly reducing maintenance costs from the outset.





Corrosion resistant

A body made in aluminium alloy with low-copper content and passivation treatment and coating makes this an ideal choice for installation where chemicals are present.

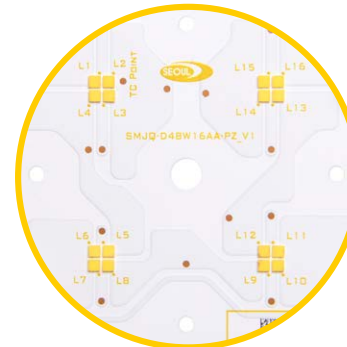

Reliable

Latest-generation LEDs can maintain luminous flux over time and have a lifetime of over 100,000 hours in ambient temperatures of 70°C.



Efficient in very high temperatures

Products in the VHT (Very High Temperature) range can be installed in ambient temperatures up to + 70°C and have a luminaire efficiency over 130 lm/W.

Easy to adjust

DALI technology is supplied with the whole range, allowing for intelligent control. Customisable adjustments allow for further energy savings.



Sizes and temperature compatibility options available

SUSPENSION

Size M

486x390x78

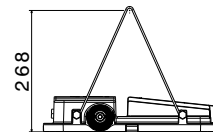
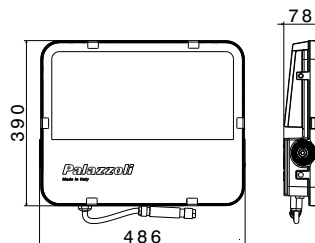

Flux ranges from 21000 to 33000 lm, comparable to a 400W JM (metal-halide) lamp.

Installation height: 9 to 20m.

Size L

804x390x78

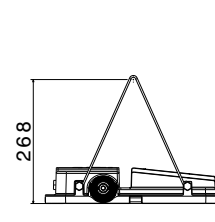
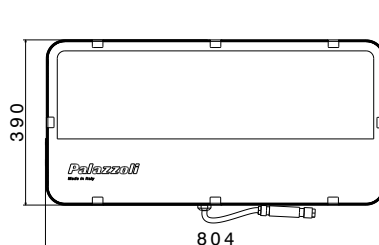

Flux ranges from 30000 to 49000 lm, comparable to a 600W SAP (sodium high pressure) lamp.

Installation height: 15 - 25 m.

VHT

(Very High Temperature)



HT

(High Temperature)

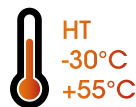

Standard

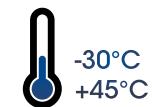



Suspension mounting

The two set brackets supplied allow for fast and secure attachment.



Adjustable double chain

Product codes 819994 and 819995 give the luminaire a 0° to 90° rotation range, allowing the luminous flux to be pointed in the optimum direction.



Ceiling mounting

The ceiling mounting kit, codes 81996 and 819997, allow the luminaire to be easily installed on ceilings.

Precision optics

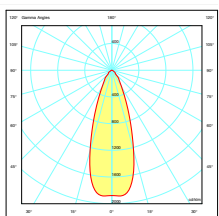

Symmetrical 36° narrow beam

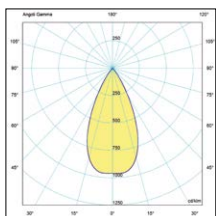

Symmetrical 55° medium beam

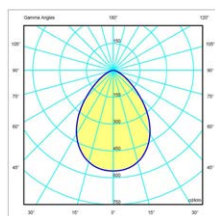

Symmetrical 81° extra wide beam

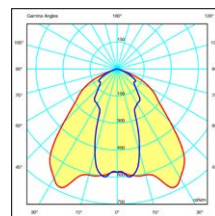

95°x41° elliptical beam

UPON REQUEST: other product codes in this catalogue are available in all versions by combining the optics and operating temperatures indicated for this range.

Elliptical optics are available upon request



X-TIGUA, Palazzoli's new suspension system, is the optimum lighting solution for places with high ambient temperatures, such as in steelworks or at the great heights required in shipyards and hangars.

A die-cast aluminium body with very low copper content, anti-corrosion treatment, and a 4mm thick diffuser in extra-clear tempered glass guarantees the durability of this luminaire. It is available in 2 sizes (M and L), providing actual output of up to 49000 lm. The rear heat sink allows for excellent heat management and increases the longevity of the luminous flux. The product is equipped with DALI drivers, which allow point-to-point adjustment of the lights, resulting in a further energy saving. The power supply unit guarantees excellent light quality with <1% flicker, allowing for video surveillance and for installation where there are rapidly rotating machines. The input surge protection secures the device against surges up to 8kV, extending product lifetime by protecting the LEDs from possible overloading. Latest-generation CSP (Chip Scale Package) LEDs can maintain luminous flux over a period of more than 120,000 hours, even in ambient temperatures up to +55°C or 100,000 hours in temperatures up to +70°C. The 4000K colour temperature and CRI≥80 guarantee ideal lighting quality wherever the product is installed. The optics are made using non-ageing, UV-resistant PMMA lenses with >90% efficiency and >95% transparency. The connector supplied with the luminaire allows for fast and secure cabling. X-TIGUA is equipped with quick connecting suspension brackets and, with specific accessories, can be ceiling mounted or hung by double chain. X-TIGUA is certified to withstand temperatures between -30°C +45°C. For extreme environments such as steelworks or rolling mills, the VHT (Very High Temperature) version can operate at up to 70°C and the HT version up to 55°C.

The photometric curves (LDT files) are available on www.palazzoli.com

Body material	Low-copper aluminium alloy (EN 44300)
Surface treatment	Passivation with fluoro-zirconium treatment
Surface coating/colour	Non-toxic polyester, anti UV, kiln-polymerised coating, colour: RAL 7011
Diffuser material	Extra clear tempered glass, thickness: 4mm
Net weight	7.5 kg - 12.1 kg
Protection rating	IP66 as per IEC/EN 60598-1
Impact resistance	IK08 as per IEC/EN 62262 + IEC/TR 62696
Mounting system	Double chain brackets
Optics features	Non-ageing, UV-resistant PMMA lenses with >90% efficiency and >95% transparency
Actual luminaire efficiency	Up to 130 lm/W
Colour temperature	4,000K (other temperatures on request)
Colour rendering index values	CRI ≥ 80 (good - according to EN 62717 criteria)
Colour consistency	MacAdam 4-step
Photobiological risk	RG0 - Exempt Group (EN 62471)
Glare index	UGR <22; UGR <25
Residual flicker	< 1%
Lifetime	L80 B20 @120,000H Tq=40°C; Tq= 55°C (HT version); L80 B20 @100,000H Tq=70°C; Tq= 55°C (HT version);
Insulation class	I
Supply voltage	220-240V 50/60Hz
Surge protection	8 kV common mode, 6kV differential mode (EN 61000-4-5)
Power factor	≥ 0.95
Ambient functioning temp.	Min -30°C to Max +45°C; Max +55°C (HT version); Max +70°C (VHT version);
Power supply	Quick connector
Max. conductor cross-section	1.5 mm²
Entry cable diameter	Min 7 mm; Max 13 mm
Warranty	2 years with optional extension to 5
Ambient storage temp.	Min -40°C; Max +70°C
Certification and approval marks	CE, ENEC, DIN 18032-3/EN 13964
Directives	2014/30/UE (EMC), 2014/35/UE (LVD), 2011/65/UE
Product standards	EN 60598-1, EN 60598-2-1, EN 60598-2-22, EN 62471, EN 62493, IEC/TR 62778, EN 55015, EN 61547, EN 61000-3-2, EN 61000-3-3, EN 50581, EN 13964 Annex D, EN 60598-2-24



VERY HIGH TEMPERATURE +70°C

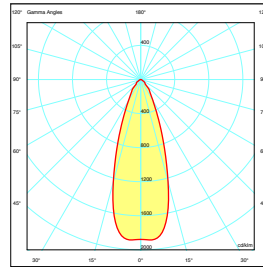

No. of LEDs	Light fixture size	Device power (W)	Nominal flux (lm) Tj= 25 °C	Output flux (lm) Tq= 25 °C	Version	Palazzoli code	Pack Qty
28	M	166	27009	21580	DALI	819528VHT	1
32	486x390	189	30867	24570		819532VHT	1
40	L	237	38584	30810		819540VHT	1
48	804x390	284	46301	36920		819548VHT	1

Suspension LED light fixtures, **VHT +70°C** glass **diffuser** optics with **36° symmetrical narrow beam** **IP66**

Equipment included: double chain bracket.
Power supply: 5Px1.5 mm² quick connector and 1.5 mm² H07RN-F cable, 0.2m in length.
Notes: the stated values may be subject to a +/- 7% tolerance.
Wireless control systems available on request.

HIGH TEMPERATURE +55°C

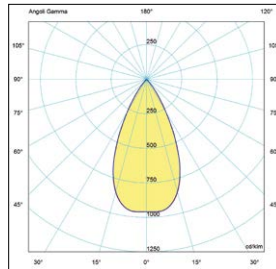

No. of LEDs	Light fixture size	Device power (W)	Nominal flux (lm) Tj= 25 °C	Output flux (lm) Tq= 25 °C	Version	Palazzoli code	Pack Qty
28	M	166	27009	21580	DALI	819428HT	1
32	486x390	189	30867	24570		819432HT	1
40	L	237	38584	30810		819440HT	1
48	804x390	284	46301	36579		819448HT	1

Suspension LED light fixtures, **HT +55°C** glass **diffuser** with **55° symmetrical medium beam** **IP66**

Equipment included: double chain bracket.
Power supply: 5Px1.5 mm² quick connector and 1.5 mm² H07RN-F cable, 0.2m in length.
Notes: the stated values may be subject to a +/- 7% tolerance.
Wireless control systems available on request.

The luminaire design is the result of careful studies of thermal simulations. The geometry of the heat sink guarantees the same temperature distribution in all installation positions and makes the LED sources and drivers highly reliable.

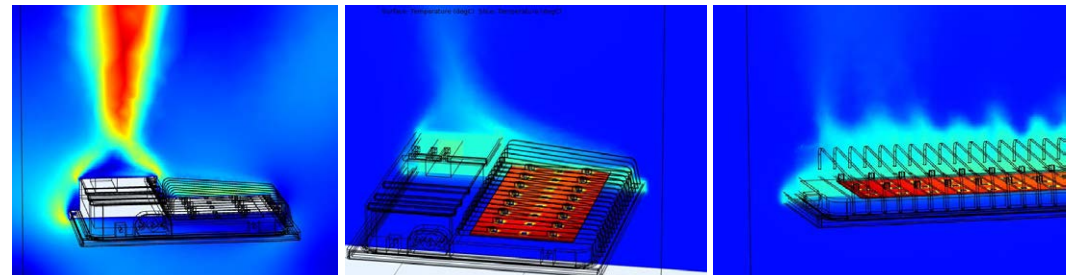

Suspension

120,000h



UGR<25

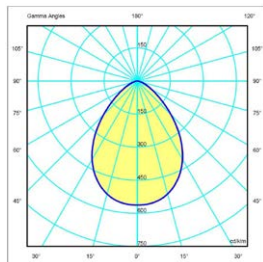

Suspension LED light fixtures,
glass diffuser optics
 with **81° symmetrical extra wide beam**
IP66

No. of LEDs	Light fixture size	Device power (W)	Nominal flux (lm) Tj= 25 °C	Output flux (lm) Tq= 25 °C	Version	Palazzoli code	Pack Qty
28	M	235	33250	28788	DALI	819328DA	1
32	486x390	270	38000	32940		819332DA	1
40	L	336	47500	41160		819340DA	1
48	804x390	400	57000	48800		819348DA	1

Equipment included: double chain bracket.
 Power supply: 5Px1.5 mm² quick connector and 1.5 mm² H07RN-F cable, 0.2m in length.
 Notes: the stated values may be subject to a +/- 7% tolerance.
 Wireless control systems available on request.

UGR<22

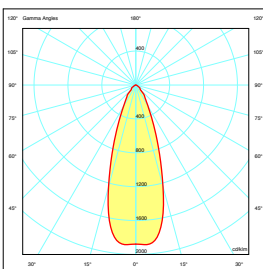

Suspension LED light fixtures,
glass diffuser optics
 with **36° symmetrical narrow beam**
IP66

No. of LEDs	Light fixture size	Device power (W)	Nominal flux (lm) Tj= 25 °C	Output flux (lm) Tq= 25 °C	Version	Palazzoli code	Pack Qty
28	M	235	33250	28670	DALI	819528DA	1
32	486x390	270	38000	32805		819532DA	1
40	L	336	47500	40992		819540DA	1
48	804x390	400	57000	48600		819548DA	1

Equipment included: double chain bracket.
 Power supply: 5Px1.5 mm² quick connector and 1.5 mm² H07RN-F cable, 0.2m in length.
 Notes: the stated values may be subject to a +/- 7% tolerance.
 Wireless control systems available on request.

Suspension accessories



Adjustable bracket
 for double chain mounting

Manufacturing material	Light fixture size	Adjustable angle	Palazzoli code	Pack Qty
galvanised steel	M	0 - 90°	819994	1
	L	0 - 10°	819995	1



Kit with bracket
 for ceiling mounting

Manufacturing material	Light fixture size	Palazzoli code	Pack Qty
galvanised steel	M	819996	1
	L	819997	1

Notes: not compatible with the VHT 70°C version.

Tunnel



REINFORCEMENT LIGHTING

is used from the entrance area to the transition zones in tunnels.

INTERIOR ZONE ILLUMINATION

also known as "permanent lighting", this is uniformly distributed from the entrance to the exit area.

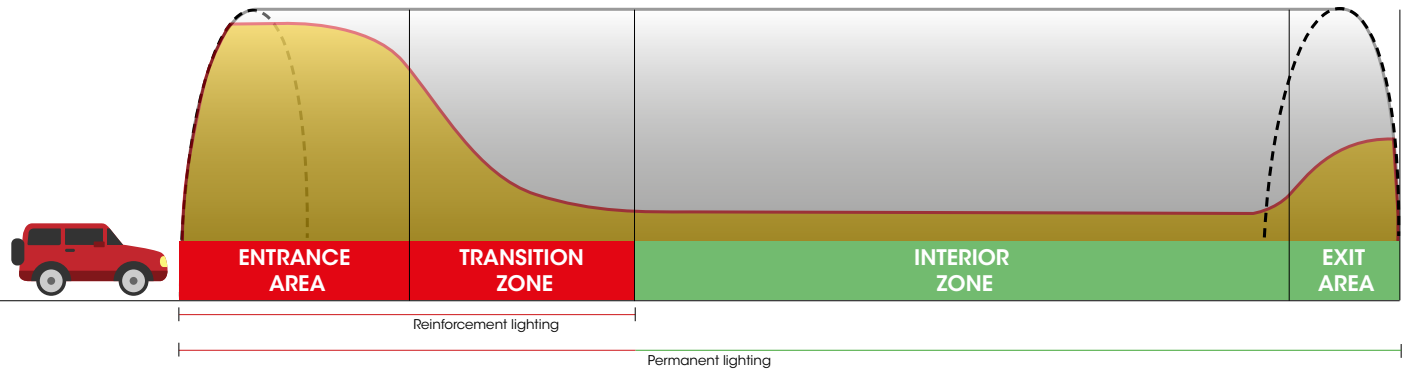

Size S

288x440x65

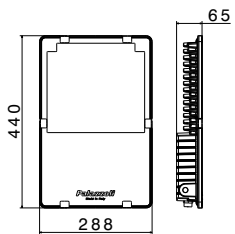

Flux ranges from 4000 to 16000 lm

Size M

481x390x78

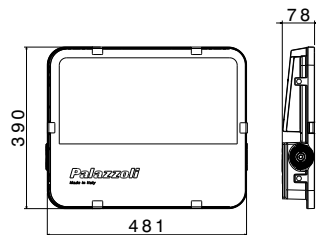

Flux ranges from 18000 to 31000 lm

Size L

799x390x78

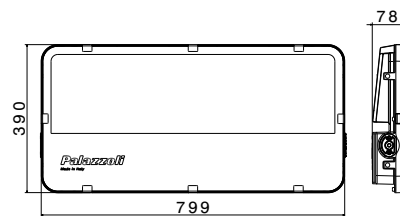

Flux ranges from 36000 to 49000 lm

Size XXL

1.290x390x78

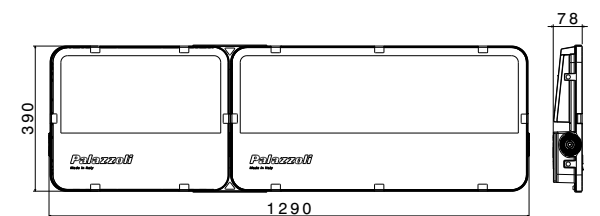

Flux 63000 lm

The dimensions, including for mounting accessories, are available in the datasheet provided with in the lighting design project

Customised solutions

Specific photometrics optimised for luminous flux distribution on the road surface have been tested in the innovative Palazzoli technical lighting laboratory, equipped with goniophotometer.



High performance electronics

The electronics chosen for the internal components guarantee high technical lighting performance that lasts over time. By using primary brands, Palazzoli does guarantee product quality and performance.



Corrosion resistant

Tunnel floodlights are equipped with AISI 304 (316L on request) stainless steel brackets which are quick fixed to the product in a way that avoids galvanic corrosion.



Adjustable upon request

The luminous flux is adjustable to very small measures, allowing for the exact luminance required. All versions are available with dimming and/or control system upon request.



Precision optics

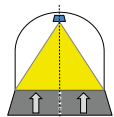
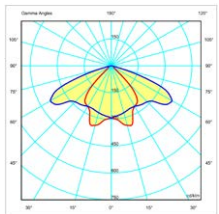

PS3 axial symmetric
transversal symmetric

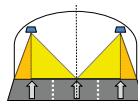
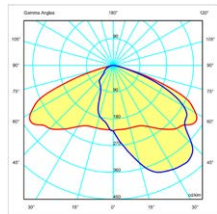

PA3 axial symmetric 25°
transversal symmetric

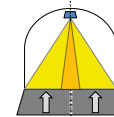
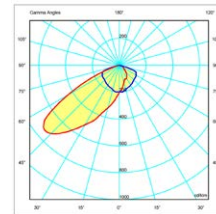

RS1 axial counterflux 52°
transversal symmetric

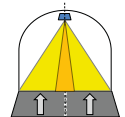
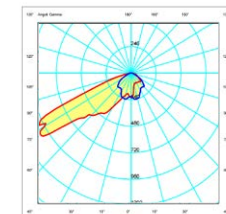

RS3 axial counterflux 62°
transversal symmetric



X-TIGUA is Palazzoli's answer to LED road tunnel lighting.

A die-cast aluminium body with very low copper content, anti-corrosion treatment, and a 4mm thick diffuser in extra-clear tempered glass guarantees maximum durability for this luminaire.

It is available in 4 floodlight sizes (S, M, L and XXL), providing effective output up to 63000 lm.

The rear heat sink allows for excellent heat management and increases the longevity of the luminous flux. The input surge protection secures the device against surges up to 10kV, extending product lifetime by protecting the LEDs from possible overloading.

High-power LEDs can maintain luminous flux over a period of more than 110000 hours. The optics are made using non-ageing, UV-resistant PMMA lenses with >90% efficiency and >95% transparency. The range includes 2x permanent optics and 2x reinforcement optics. Furthermore, Palazzoli can create customised optics according to specific project requirements. They are connected to the network via a 1.5m multicore FTG10(O)M1 cable and 2P 16A 230V standard industrial plug, compliant with standards CEI EN 60309-1 and CEI EN 60309-2. A wide range of AISI 304 stainless steel accessories is available for hanging the product using products designed to avoid galvanic corrosion. Installation on a cable trunking is possible without the help of further tools as it has a guided quick coupling system.

Tunnel sockets and boxes complete this lighting range. You can view these on the website: www.palazzoli.com

The photometric curves (LDT files) are available on www.palazzoli.com

Body material	Low-copper aluminium alloy (EN 44300)
Surface treatment	Passivation with fluoro-zirconium treatment
Surface coating/colour	Non-toxic polyester, anti UV, kiln-polymerised coating, colour: RAL 7011
Diffuser material	Extra clear tempered glass, thickness: 4mm
Net weight	7.3 kg - 12kg - 19.3 kg
Protection rating	IP66 as per IEC/EN 60598-1
Impact resistance	IK08 as per IEC/EN 62262 + IEC/TR 62696
Optics features	Non-ageing, UV-resistant PMMA lenses with >90% efficiency and >95% transparency
Actual luminaire efficiency	Up to 130 lm/W
Colour temperature	4,000K (other temperatures on request)
Colour rendering index values	CRI ≥ 70 (good - according to EN 62717 criteria)
Colour consistency	MacAdam 5-step
Photobiological risk	RG0 - Exempt Group (EN 62471)
Residual flicker	< 1%
Lifetime	L90 B10 @110,000H Tq=40°C;
Insulation class	II
Supply voltage	220-240V 50/60Hz
Control/dimming system	Upon request for remote controlled versions
Surge protection	10 kV common mode, 8kV differential mode (EN 61000-4-5)
Power factor	≥ 0.98
Ambient functioning temp.	Min -30°C - Max +45°C;
Power supply	16A 2P IP67 IEC EN 60309-1/-2 plug with FTG10(O)M1 1.5 mm² cable;
Warranty	2 years with optional extension to 10
Ambient storage temp.	Min -40°C; Max +70°C
Certification and approval marks	CE, ENEC
Directives	2014/30/EU (EMC), 2014/35/EU (LVD), 2011/65/EU (RoHS)
Product standards	EN 60598-1, EN 60598-2-3, EN 62471, EN 62493, IEC/TR 62778, EN 55015, EN61547, EN 61000-3-2, EN 61000-3-3, EN 50581, EN 62717, EN 62722-2-1, EN 61347-1, EN 61347-2-13, EN62384, EN 13032-4

Tunnel
110,000h

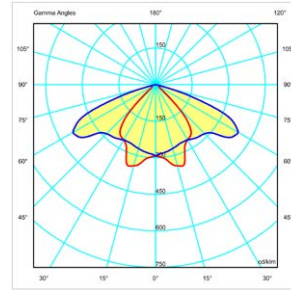

Tunnel floodlights with **PS3 axially symmetrical** and **transversally symmetrical optics IP66**

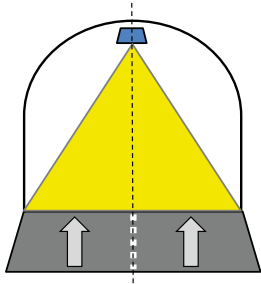

No. of LEDs	Floodlight size	Device power (W)	Nominal flux (lm) Tj= 25 °C	Output flux (lm) Tq= 25 °C	Version	Palazzoli code	Pack Qty
4		35	5220	4160	standard on-off	811404	1
6		51	7830	6240		811406	1
8		67	10440	8320		811408	1
9	S 288x440	75	11745	9360		811409	1
12		100	15660	12480		811412	1
14		116	18270	14560		811414	1
15		124	19575	15600		811415	1
18		152	23490	19468		812418	1
24	M 481x390	203	31320	25388		812424	1
30		253	39150	31850		812430	1
36		303	46980	38220		812436	1
42	L 799x390	349	54810	43863		812442	1
48		397	62640	49663		812448	1
60	XXL 1290x390	507	78300	63608		812460	1

Equipment included: power supply through 16A 2P IP67 IEC EN 60309-1/-2 plug with FTG10(O)M1 1.5 mm² cable.
Notes: the stated values may be subject to a +/- 7% tolerance.
Dimmable version on request.

Tunnel

110,000h

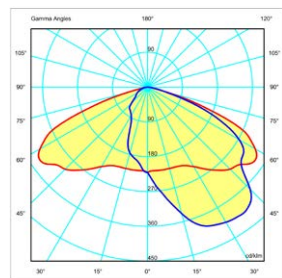

Tunnel floodlights with **PA3 axially symmetrical** and **transversally asymmetrical 25° optics**
IP66

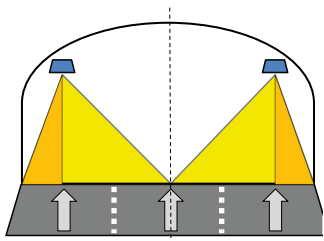

No. of LEDs	Floodlight size	Device power (W)	Nominal flux (lm) Tj= 25 °C	Output flux (lm) Tq= 25 °C	Version	Palazzoli code	Pack Qty
4		35	5220	4160	standard on-off	811454	1
6		51	7830	6240		811456	1
8		67	10440	8320		811458	1
9	S 288x440	75	11745	9360		811459	1
12		100	15660	12480		811462	1
14		116	18270	14560		811464	1
15		124	19575	15600		811465	1
18		152	23490	18889		812318	1
24	M 481x390	203	31320	24634		812324	1
30		253	39150	30904		812330	1
36		303	46980	37085		812336	1
42	L 799x390	349	54810	42560		812342	1
48		397	62640	48188		812348	1
60	XXL 1290x390	507	78300	61719		812360	1

Equipment included: power supply through 16A 2P IP67 IEC EN 60309-1/-2 plug with FTG10(O)M1 1.5 mm² cable.
Notes: the stated values may be subject to a +/- 7% tolerance.
Dimmable version on request.

Tunnel

110,000h

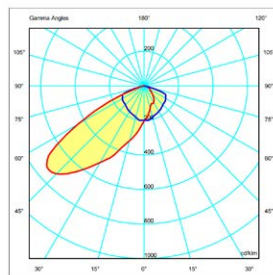

Tunnel floodlights with **RS1 axial counterflux** and **transversally symmetrical 52° optics**
IP66

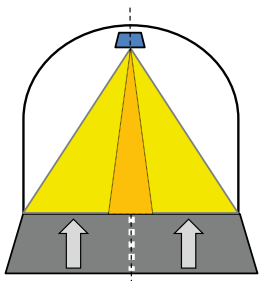

No. of LEDs	Floodlight size	Device power (W)	Nominal flux (lm) Tj= 25 °C	Output flux (lm) Tq= 25 °C	Version	Palazzoli code	Pack Qty
4		35	5220	4160	standard on-off	811504	1
6		51	7830	6240		811506	1
8		67	10440	8320		811508	1
9	S 288x440	75	11745	9360		811509	1
12		100	15660	12480		811512	1
14		116	18270	14560		811514	1
15		124	19575	15600		811515	1
18		152	23490	19275		812518	1
24	M 481x390	203	31320	25137		812524	1
30		253	39150	31535		812530	1
36		303	46980	37841		812536	1
42	L 799x390	349	54810	43429		812542	1
48		397	62640	49171	812548	1	
60	XXL 1290x390	507	78300	62978	812560	1	

Equipment included: power supply through 16A 2P IP67 IEC EN 60309-1/-2 plug with FTG10(O)M1 1.5 mm² cable.
Notes: the stated values may be subject to a +/- 7% tolerance.
Dimmable version on request.

Tunnel

110,000h

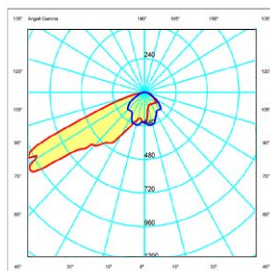

Tunnel floodlights with **RS3 axial counterflux** and **transversally symmetrical 62° optics IP66**

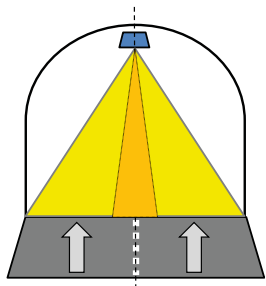

No. of LEDs	Floodlight size	Device power (W)	Nominal flux (lm) Tj= 25 °C	Output flux (lm) Tq= 25 °C	Version	Palazzoli code	Pack Qty
4		35	5220	4160	standard on-off	811654	1
6		51	7830	6240		811656	1
8		67	10440	8320		811658	1
9	S 288x440	75	11745	9360		811659	1
12		100	15660	12480		811662	1
14		116	18270	14560		811664	1
15		124	19575	15600		811665	1
18		152	23490	18311		812618	1
24	M 481x390	203	31320	23880		812624	1
30		253	39150	29958		812630	1
36		303	46980	35949		812636	1
42	L 799x390	349	54810	41257		812642	1
48		397	62640	46713		812648	1
60	XXL 1290x390	507	78300	59829		812660	1

Equipment included: power supply through 16A 2P IP67 IEC EN 60309-1/-2 plug with FTG10(O)M1 1.5 mm² cable.
Notes: the stated values may be subject to a +/- 7% tolerance.
Dimmable version on request.



Pair of quick fitting brackets
in AISI 304 stainless steel
for axial adjustment
for TIGUA luminaires

Manufacturing material	For floodlight size	Axial adjustment	Trunking size	Palazzoli code	Pack Qty
AISI 304 stainless steel	S	6°	100x75	811931	1
			200x75	811932	1
			300x75	811933	1
			100x100	811934	1
			200x100	811935	1
	S	8°	100x75	811937	1
			200x75	811938	1
			300x75	811939	1
			100x100	811940	1
			200x100	811941	1
	S	10°	100x75	811943	1
			200x75	811944	1
			300x75	811945	1
			100x100	811946	1
			200x100	811947	1
			300x100	811948	1



Pair of quick fitting brackets
in AISI 304 stainless steel
for axial adjustment
for X-TIGUA luminaires

Manufacturing material	For floodlight size	Axial adjustment	Trunking size	Palazzoli code	Pack Qty
AISI 304 stainless steel	M L XXL	6°	100x75	812931	1
			200x75	812932	1
			300x75	812933	1
			100x100	812934	1
			200x100	812935	1
	M L XXL	8°	100x75	812937	1
			200x75	812938	1
			300x75	812939	1
			100x100	812940	1
			200x100	812941	1
	M L XXL	10°	100x75	812943	1
			200x75	812944	1
			300x75	812945	1
			100x100	812946	1
			200x100	812947	1
			300x100	812948	1



Pair of quick fitting brackets in AISI 304 stainless steel

Manufacturing material	For floodlight size	Trunking size	Palazzoli code	Pack Qty
AISI 304 stainless steel	S	100x75	811900	1
		200x75	811901	1
	M	300x75	811902	1
	L	100x100	811903	1
	XXL	200x100	811904	1
			300x100	811905



Pair of quick fitting brackets in AISI 304 stainless steel for transversal adjustment

Manufacturing material	For floodlight size	Trunking size	Palazzoli code	Pack Qty
AISI 304 stainless steel	S	100x75	811925	1
		200x75	811926	1
	M	300x75	811927	1
	L	100x100	811928	1
	XXL	200x100	811929	1
			300x100	811930



Pair of brackets in AISI 304 stainless steel for direct screw mounting

Manufacturing material	For floodlight size	Palazzoli code	Pack Qty
AISI 304 stainless steel	S,M,L,XXL	811906	1



Pair of adjustable brackets in AISI 304 stainless steel for direct screw mounting

Manufacturing material	For floodlight size	Palazzoli code	Pack Qty
AISI 304 stainless steel	S,M,L,XXL	811907	1

55686E

X-TIGUA

by Palazzoli

Lighting to save

palazzoli.com

Palazzoli S.p.A. Via F. Palazzoli, 31 - 25128 Brescia - Italy
Tel. +39 030 2015.1 - Fax +39 030 2015.258
export@palazzoli.com

Palazzoli